

MID-7654/7652 Servo Power Motor Drive User Guide and Specifications



This user guide describes the electrical and mechanical aspects of the MID-7654/7652 servo power motor drive and describes how to use the MID-7654/7652 with your motion controller.

Contents

Conventions	2
Introduction.....	2
What You Need to Get Started	3
Safety Information	3
Electromagnetic Compatibility Information	5
Front Panel Switches	6
Host Bus Interlock Circuit	7
Front Panel LEDs.....	7
Amplifier Fault Output LEDs	7
Amplifier Inhibit LEDs.....	7
Limit Status LEDs	8
Front Panel DIP Switch Settings	8
Inhibit Input Polarity Setting	9
Inhibit Output Polarity Setting.....	9
Limit Status LED Polarity Setting.....	9
Setting Continuous and Peak Current Limits	10
Setting Motor Inductance Levels	13
Back Panel Connector Wiring	14
Terminal Block Wiring	15
Servo Motor Power Terminal Blocks	15
Rear Guard.....	16
Encoder Terminal Blocks	19
Limit Switch Terminal Blocks.....	21
Breakpoint and Trigger Terminal Blocks	21
Analog I/O Terminal Blocks.....	22
Step and Direction Terminal Block	22
Cable Installation for CE Compliance	23
Accessories Included for Optional Use	24
Strain-Relief Bar Installation.....	24
Panel Mount Kit Installation.....	25
Modifying the Power Entry Module.....	25
Replacing a Fuse	25
Changing the Line Voltage	26
Amplifier/Driver Command Signals.....	26
Specifications.....	26
Where to Go for Support	30

Conventions

The following conventions are used in this guide:

- » The » symbol leads you through nested menu items and dialog box options to a final action. The sequence **Options»Settings»General** directs you to pull down the **Options** menu, select the **Settings** item, and select **General** from the last dialog box.
-  This icon denotes a note, which alerts you to important information.
-  This icon denotes a caution, which advises you of precautions to take to avoid injury, data loss, or a system crash. When this symbol is marked on a product, refer to the *Specifications* section of this guide for information about precautions to take.
-  When this symbol is marked on a product, it denotes a component that may be hot. Touching this component may result in bodily injury.
- bold** Bold text denotes items that you must select or click in the software, such as menu items and dialog box options. Bold text also denotes parameter names.
- italic* Italic text denotes variables, emphasis, a cross-reference, or an introduction to a key concept. Italic text also denotes text that is a placeholder for a word or value that you must supply.
- monospace Text in this font denotes text or characters that you should enter from the keyboard, sections of code, programming examples, and syntax examples. This font is also used for the proper names of disk drives, paths, directories, programs, subprograms, subroutines, device names, functions, operations, variables, filenames, and extensions.
- overline Indicates the signal is active low.

Introduction

The National Instruments MID-7654/7652 servo power motor drive is a complete power amplifier and system interface for use with four or two axes of simultaneous servo motion control, respectively. The MID-7654/7652 is ideal for industrial and laboratory applications and has everything you need to connect motors, encoders, limit switches, I/O, and other motion hardware to National Instruments motion controllers.

The MID-7654/7652 can drive a broad range of servo motors with its pulse-width modulation (PWM) amplifiers with user-specified peak and continuous output current settings. In all configurations, power supplies are built in and use standard 240/120 VAC for operation. Electronics are fan-cooled to ensure reliable operation.

The MID-7654/7652 simplifies your field wiring through separate encoder, limit switch, and motor power removable screw terminal connector blocks for each axis. The terminal blocks do not require any special wiring tools for installation. The MID-7654/7652 connects to National Instruments motion controllers via a 68-pin, high-density interconnect cable.

The MID-7654/7652 has four levels of amplifier inhibit/disable protection for motion system shut down. The front panel contains both enable and power switches for direct motor inhibiting and system power-down operations. The MID-7654/7652 also has a host bus power interlock that activates an internal driver inhibit signal if the host computer is shut down or if the motion controller interface cable is disconnected. The inhibit input from the back panel connectors also inhibits the servo drives when activated.

You can use the MID-7654/7652 enclosure as a benchtop unit, panel mounted using a panel mount kit, or rack-mounted using a 19-inch standard rack kit.

What You Need to Get Started

To set up and use your MID-7654/7652 accessory, you must have the following items:

- The MID-7654/7652 servo power motor drive with attached rear guard
- Power cord (IEC type)
- Strain-relief bar, NI part number 187407-01 (included)
- Panel-mount kit, NI part number 187243-01 (included)
- SHC68-C68-S shielded cable assembly, NI part number 186380-02 (not included)

Refer to the [Specifications](#) section of this document for detailed specifications for the MID-7654/7652.

Safety Information

The following section contains important safety information that you must follow when installing and using the hardware.

Do not operate the hardware in a manner not specified in this document and in the user documentation. Misuse of the hardware can result in a hazard. You can compromise the safety protection if the hardware is damaged in any way. If the hardware is damaged, return it to National Instruments for repair.

Clean the hardware with a soft, nonmetallic brush. Make sure that the hardware is completely dry and free from contaminants before returning it to service.

Do not substitute parts or modify the hardware except as described in this document. Use the hardware only with the chassis, modules, accessories, and cables specified in the installation instructions or specifications. You must have all covers and filler panels installed during operation of the hardware.

Do not operate the hardware in an explosive atmosphere or where there may be flammable gases or fumes unless the hardware is UL (U.S.) or Ex (EU) Certified and marked for hazardous locations. The hardware must be in a suitably rated IP 54 minimum enclosure for hazardous locations.

You must insulate signal connections for the maximum voltage for which the hardware is rated. Do not exceed the maximum ratings for the hardware. Do not install wiring while the hardware is live with electrical signals. Do not remove or add connector blocks when power is connected to the system. Avoid contact between your body and the connector block signal when hot swapping hardware. Remove power from signal lines before connecting them to or disconnecting them from the hardware.



Caution The MID-7654/7652 does not provide overload protection for motor loads. Overload protection *must* be provided externally by the system designer.



Caution The MID-7654/7652 does not provide motor overtemperature sensing. External temperature sensing *must* be provided externally by the system designer. Temperature sensing is required for monitoring the motor temperature and disabling the drive.



Caution When connecting or disconnecting signal lines to the MID-7654/7652 terminal block screw terminals, make sure the lines are powered off. Potential differences between the lines and the MID-7654/7652 ground create a shock hazard while you connect the lines.



Caution Connections that exceed any of the maximum signal ratings on the MID-7654/7652 device can create a shock or fire hazard or can damage any or all of the motion controllers connected to the MID-7654/7652 chassis, the host computer, and the MID-7654/7652 device. This includes power signals to ground and vice versa. National Instruments is *not* liable for any damages or injuries resulting from incorrect signal connections.



Caution The servo motor connectors on this drive are energized when the unit is powered on. The rear guard must be in place at all times while the unit is connected to a power outlet. Disconnect the MID-7654/7652 unit from power outlet before connecting wires to or disconnecting wires from the servo motor connectors. Strip back the insulation of the servo motor wires to the servo motor connectors no more than 7 mm. Reattach the rear guard before you reconnect the unit to a power outlet. ***Failure to do so could result in electric shock leading to serious bodily injury or death.*** Refer to the *Rear Guard* section of this document for more information.



Hot Surface The bottom surface of the MID-7654/7652 can get very hot to the touch under certain conditions. To avoid a burn hazard, refer to the *Setting Continuous and Peak Current Limits* section within the *Front Panel DIP Switch Settings* section of this guide for the appropriate current setting and safety hazards.

Operate the hardware only at or below Pollution Degree 2. Pollution is foreign matter in a solid, liquid, or gaseous state that can reduce dielectric strength or surface resistivity. The following is a description of pollution degrees:

- Pollution Degree 1 means no pollution or only dry, nonconductive pollution occurs. The pollution has no influence. Typical level for sealed components or coated PCBs.
- Pollution Degree 2 means that only nonconductive pollution occurs in most cases. Occasionally, however, a temporary conductivity caused by condensation must be expected. Typical level for most products.
- Pollution Degree 3 means that conductive pollution occurs, or dry, nonconductive pollution occurs that becomes conductive due to condensation.



Note The MID-7654/7652 is intended for indoor use only.

Operate the hardware at or below the measurement category¹ marked on the hardware label. Measurement circuits are subjected to working voltages² and transient stresses (overvoltage) from the circuit to which they are connected during measurement or test. Measurement categories establish standard impulse withstand voltage levels that commonly occur in electrical distribution systems. The following is a description of measurement categories:

- Measurement Category I is for measurements performed on circuits not directly connected to the electrical distribution system referred to as MAINS³ voltage. This category is for measurements of voltages from specially protected secondary circuits. Such voltage measurements include signal levels, special hardware, limited-energy parts of hardware, circuits powered by regulated low-voltage sources, and electronics.
- Measurement Category II is for measurements performed on circuits directly connected to the electrical distribution system (MAINS³). This category refers to local-level electrical distribution, such as that provided by a standard wall outlet (for example, 115 AC voltage for U.S. or 230 AC

¹ Measurement categories, also referred to as overvoltage or installation categories, are defined in electrical safety standard IEC 61010-1 and IEC 60664-1.

² Working voltage is the highest rms value of an AC or DC voltage that can occur across any particular insulation.

³ MAINS is defined as a hazardous live electrical supply system that powers hardware. Suitably rated measuring circuits may be connected to the MAINS for measuring purposes.

voltage for Europe). Examples of Measurement Category II are measurements performed on household appliances, portable tools, and similar hardware.

- Measurement Category III is for measurements performed in the building installation at the distribution level. This category refers to measurements on hard-wired hardware such as hardware in fixed installations, distribution boards, and circuit breakers. Other examples are wiring, including cables, bus bars, junction boxes, switches, socket outlets in the fixed installation, and stationary motors with permanent connections to fixed installations.
- Measurement Category IV is for measurements performed at the primary electrical supply installation typically outside buildings. Examples include electricity meters and measurements on primary overcurrent protection devices and on ripple control units.

To obtain the safety certification(s) for this product, visit ni.com/certification, search by model number or product line, and click the appropriate link in the Certification column.

Electromagnetic Compatibility Information

This hardware has been tested and found to comply with the applicable regulatory requirements and limits for electromagnetic compatibility (EMC) as indicated in the hardware's Declaration of Conformity (DoC)¹. These requirements and limits are designed to provide reasonable protection against harmful interference when the hardware is operated in the intended electromagnetic environment. In special cases, for example when either highly sensitive or noisy hardware is being used in close proximity, additional mitigation measures may have to be employed to minimize the potential for electromagnetic interference.

While this hardware is compliant with the applicable regulatory EMC requirements, there is no guarantee that interference will not occur in a particular installation. To minimize the potential for the hardware to cause interference to radio and television reception or to experience unacceptable performance degradation, install and use this hardware in strict accordance with the instructions in the hardware documentation and the DoC¹.

If this hardware does cause interference with licensed radio communications services or other nearby electronics, which can be determined by turning the hardware off and on, you are encouraged to try to correct the interference by one or more of the following measures:

- Reorient the antenna of the receiver (the device suffering interference).
- Relocate the transmitter (the device generating interference) with respect to the receiver.
- Plug the transmitter into a different outlet so that the transmitter and the receiver are on different branch circuits.

Some hardware may require the use of a metal, shielded enclosure (windowless version) to meet the EMC requirements for special EMC environments such as, for marine use or in heavy industrial areas. Refer to the hardware's user documentation and the DoC¹ for product installation requirements.

When the hardware is connected to a test object or to test leads, the system may become more sensitive to disturbances or may cause interference in the local electromagnetic environment.

Operation of this hardware in a residential area is likely to cause harmful interference. Users are required to correct the interference at their own expense or cease operation of the hardware.

Changes or modifications not expressly approved by National Instruments could void the user's right to operate the hardware under the local regulatory rules.

¹ The Declaration of Conformity (DoC) contains important EMC compliance information and instructions for the user or installer. To obtain the DoC for this product, visit ni.com/certification, search by model number or product line, and click the appropriate link in the Certification column.

Front Panel Switches

Figure 1 shows the front panel for your MID-7654/7652. The DIP switches are shown with the detachable metal cover plate removed.

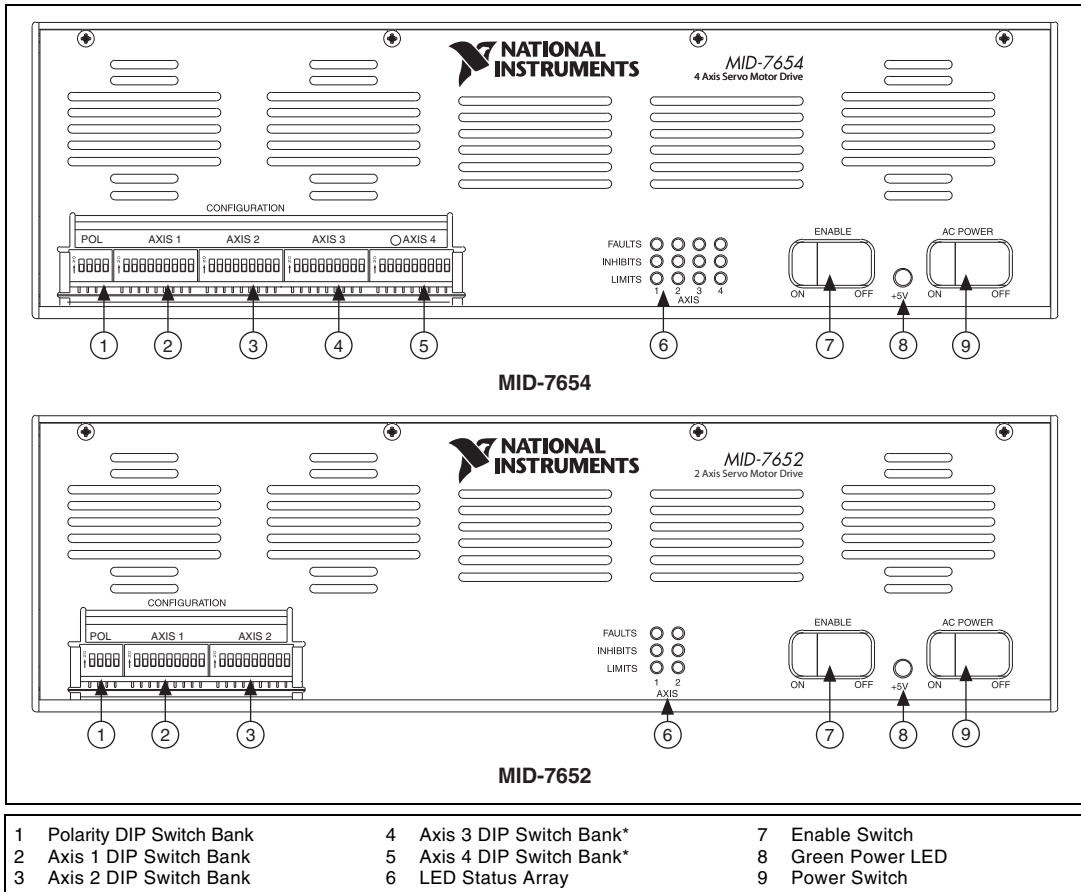

Figure 1. MID-7654/7652 Front Panel



Note Items followed by an asterisk (*) are available on the MID-7654 only.

There are two rocker switches on the MID-7654/7652 front panel: AC POWER and ENABLE. Figure 1 illustrates the location of these switches.

The AC POWER switch energizes the motor bus (+48 V) and the logic (+5 V) power supplies. When switched on, the green power LED labeled +5 V illuminates. If this LED fails to illuminate, check the power cord and main input fuse on the back panel.

The ENABLE switch enables or inhibits the servo amplifiers. If the ENABLE switch is in the inhibit position (OFF), the amplifier output stages are inhibited and the yellow LEDs for all axes illuminate. See the [Front Panel LEDs](#) section of this guide for more information.

Both the AC POWER and ENABLE switches can inhibit the servo amplifiers. However, as long as the AC POWER switch is on, only the servo amplifier output stages are disabled. The remaining circuitry remains active, including the quadrature encoder circuit.



Caution You *must* change the MID-7654/7652 main input fuse on the rear panel if you change the line voltage from the factory setting. Refer to the [Specifications](#) section of this guide for fuse specifications. Refer to the [Modifying the Power Entry Module](#) section for more information on handling the power entry module.

Host Bus Interlock Circuit

The MID-7654/7652 has a host bus interlock circuit that monitors the presence of +5 V from the host computer and disables the MID-7654/7652 when the voltage is not present or falls out of tolerance. This circuit shuts down the servo amplifiers for all axes by activating the inhibit when the host computer is disconnected from the MID-7654/7652 or inadvertently shut down. Activation of the host bus interlock circuitry illuminates the yellow LEDs (middle row) of the LED status array for all axes. See the [Front Panel LEDs](#) section of this guide for more information.

Front Panel LEDs

The front panel LEDs consist of a single green LED to indicate if the main 5 V power is active. If the DC power supplies are active, the green power LED illuminates. If this LED fails to illuminate, check the power cord and the main input fuse on the front panel.

An LED status array of 3 rows by 4 columns on the MID-7654 or 3 rows by 2 columns on the MID-7652 provides a variety of status information. Refer to Figure 1 for the location of the front panel LEDs. The LED status array is arranged by motor axes. Each of the four columns represents an axis, and each of the three rows represents a particular status. Table 1 summarizes the axes and statuses to which the different LEDs in the 3 × 4 or 3 × 2 array correspond.

Table 1. Front Panel LED Indicators

Status	Motor Axis			
Amplifier Fault Output (red)	1	2	3*	4*
Amplifier Inhibit (yellow)	1	2	3*	4*
Limit Status (green)	1	2	3*	4*
* These LEDs only appear on the MID-7654.				

Amplifier Fault Output LEDs

The top row of the LED status array indicates the status of the amplifiers. A red LED indicates an overcurrent condition, a short circuit condition, an over temperature condition, or a problem with the motor bus voltage on that axis.

Amplifier Inhibit LEDs

The middle row of the LED status array indicates if a motor axis is inhibited. An axis is inhibited and the LED illuminates yellow if the host bus interlock circuitry is activated from the back panel, if the ENABLE switch on the front panel is in the inhibit position, if the motion controller's inhibit signal is low, or if the per-axis inhibit input is actively driven. You can select the polarity of the per-axis inhibit input from the front panel DIP switches. See the [Front Panel DIP Switch Settings](#) section of this guide for more information.

Limit Status LEDs

The bottom row of the LED status array indicates if a limit switch is currently active. The LED illuminates green when either the forward or reverse limit switch is active for each axis. You can select the polarity for the limit status LEDs from the front panel DIP switches. See the *Front Panel DIP Switch Settings* of this guide for more information.

Front Panel DIP Switch Settings

The MID-7654/7652 front panel has a detachable metal plate that, when removed, provides access to one 4-position DIP switch bank and either four (MID-7654) or two (MID-7652) 9-position DIP switch banks. Refer to Figure 1 for the location of these switches.

Use the DIP switches on the 4-position DIP switch bank to configure the inhibit in, inhibit out, and limit status LED polarity as shown in Figure 2. The different settings for these switches are described in the following sections.

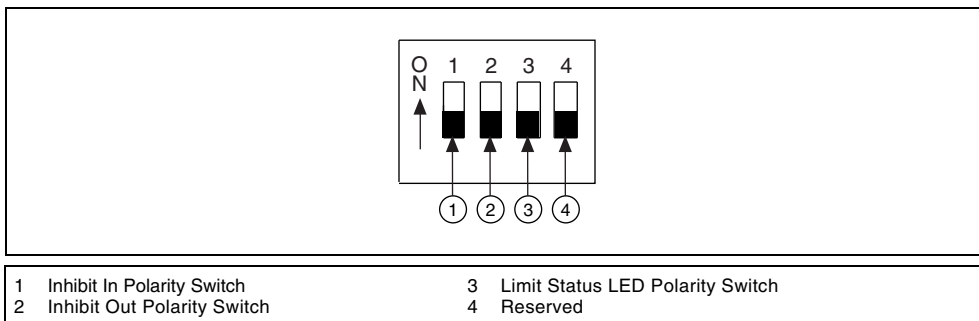

Figure 2. 4-Position DIP Switch Bank Layout

Use the DIP switches on each 9-position DIP switch bank to configure the continuous current limit, the peak current limit, and the motor inductance (low or standard) for each axis, as shown in Figure 3. The different settings for these switches are described in the following sections.

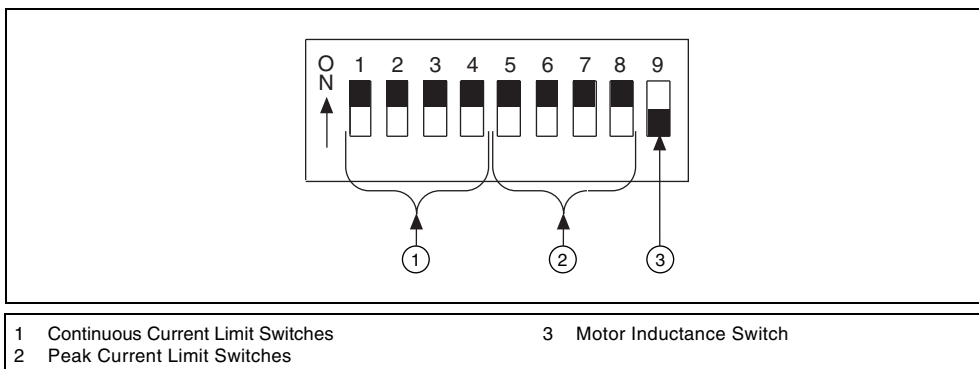



Figure 3. 9-Position DIP Switch Bank Layout

Inhibit Input Polarity Setting

Use DIP switch 1 on the 4-position DIP switch bank to globally set the polarity for the inhibit input for all axes. Refer to Figures 1 and 3 for the location of this switch.

The factory-default setting of DIP switch 1 is active-low. If the inhibit input is active, the axis is inhibited and the yellow status LED (middle row) corresponding to that axis illuminates. Table 2 shows the DIP switch setting for the inhibit input polarity selection.

Table 2. Inhibit Input Polarity DIP Switch Settings



Switch Setting	Operation
	Active-high
	Active-low (factory default)

Inhibit Output Polarity Setting

Use DIP switch 2 on the 4-position DIP switch bank to globally set the polarity for the inhibit output for all axes. Refer to Figures 1 and 3 for the location of this switch.

The factory-default setting of DIP switch 2 is active-high. Table 3 shows the DIP switch setting for the inhibit output polarity selection.

Table 3. Inhibit Output Polarity DIP Switch Settings



Switch Setting	Operation
	Active-high (factory default)
	Active-low

Limit Status LED Polarity Setting

Use DIP switch 3 on the 4-position DIP switch bank to globally set the polarity for the Limit Status LED. Refer to Figures 1 and 3 for the location of this switch.

The factory-default setting is active-high. Typically, you set the switch to match the polarity setting on your controller, so if either the reverse or forward limits for an axis are active, the green status LED (on the bottom row) corresponding to that axis illuminates. This DIP switch alters only the polarity for the LEDs, not the actual limit to the motion controller. Table 4 shows the DIP switch setting for the Limit Status LED polarity selection.

Table 4. Limit Status LED DIP Switch Settings

Switch Setting	Operation
	Active-high (factory default)
	Active-low

Setting Continuous and Peak Current Limits

The MID-7654/7652 uses high-efficiency PWM amplifiers configured as torque blocks (current amplifiers or transconductance amplifiers). The *peak current limit* is the maximum current your motor can withstand for short periods of time. The *continuous current limit* is the maximum current your motor can withstand indefinitely.



Caution To avoid overheating the drive under a motor fault condition, ensure the following error limit is set above zero in the motion controller configuration software. The default following error limit is 32,767.

Figure 4 illustrates the command voltage input to current output relationship for periods of time less than 2.7 seconds.

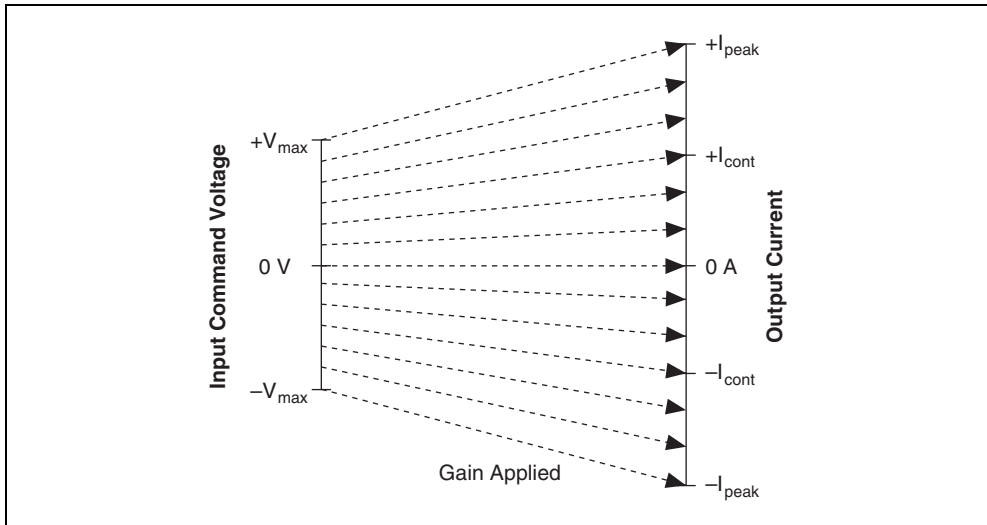

Figure 4. Input Voltage to Output Current Relationship for Periods of Time Less Than 2.7 Seconds

Figure 5 shows the command voltage input to current output relationship for periods of time greater than 2.7 seconds. The maximum current output corresponds to the continuous current limit, I_{cont} . Therefore, command voltages that would result in a higher current output than I_{cont} when the gain is applied instead result in a current output of I_{cont} .

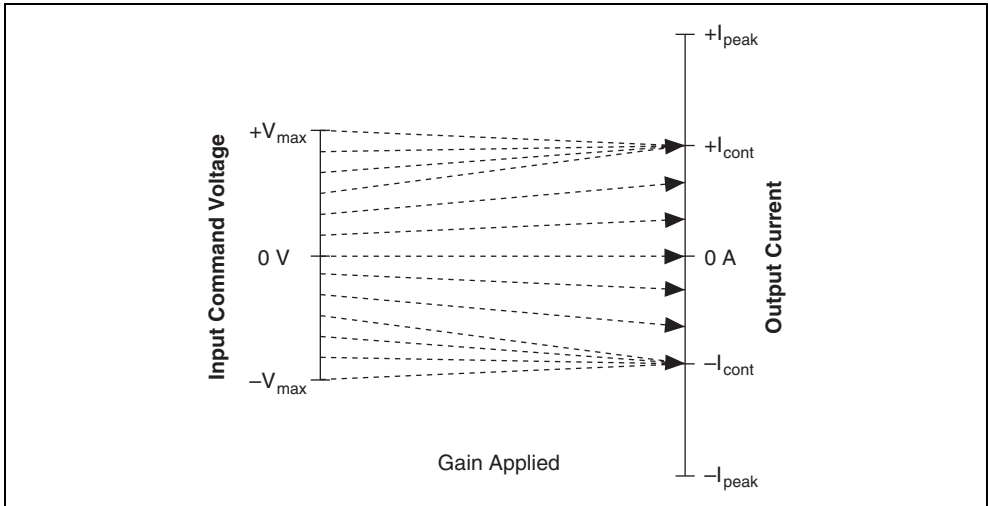

Figure 5. Input Voltage to Output Current Relationship for Periods of Time Greater Than 2.7 Seconds

The amplifier peak and continuous current limits have been factory set for 5 A continuous current output and 10 A peak current output. Verify that these settings are appropriate for your application before powering your motors.

Use DIP switches 1 through 4 on each of the 9-position DIP switch banks to set the continuous current limit for each axis. Use DIP switches 5 through 8 on each of the 9-position DIP switch banks to set the peak current limit for each axis. Refer to Figures 1 and 3 for the location of the continuous current limit and peak current limit switches. Table 5 shows the DIP switch settings for all possible current limit settings.













Note The switches shown in Table 5 show the settings for switches 1 through 4, which are the continuous current DIP switches. Configure the settings for switches 5 through 8 in the same manner to set the peak current values.

Table 5. Continuous and Peak Output Current DIP Switch Settings

Switch	Continuous Current (A)	Peak Current (A)	Switch	Continuous Current (A)	Peak Current (A)
	5.00	10.00		1.25	2.50
	4.50	9.00		1.15	2.30
	3.80	7.55		1.10	2.20

Table 5. Continuous and Peak Output Current DIP Switch Settings (Continued)

Switch	Continuous Current (A)	Peak Current (A)	Switch	Continuous Current (A)	Peak Current (A)
	3.00	6.00		1.05	2.10
	2.45	4.90		1.00	1.95
	2.10	4.20		0.95	1.85
	1.95	3.85		0.90	1.80
	1.70	3.45		0.85 (default)	1.70 (default)

If you are connecting multiple motors to your MID-7654/7652, verify that the total power dissipated by the motors at any given time is less than the total power the drive can provide. If the total power requirement exceeds the capability of the drive at any point, the drive will provide less power to the motors than desired until the total power requirement drops back down. Your MID-7654/7652 may overheat under continuous operation with loads that exceed specified limits.



Caution A fire safety hazard exists when the total power dissipated by the motors exceeds 400 W at 25% duty cycle for a sustained period of time.

To determine the maximum total power dissipation of all of the motors combined, add up the maximum power each motor can dissipate. If this value is less than or equal to 400 W at 25% duty cycle, you will not exceed the capabilities of the MID-7654/7652.

If the value is greater than 400 W at 25% duty cycle, you may still be within the operating capabilities of the MID-7654/7652, since it is unlikely you will run all of your motors simultaneously at their maximum levels. Make a reasonable estimation of the maximum power your motors will require at any given time and verify that this value is less than 400 W at 25% duty cycle.

Setting Motor Inductance Levels



Depending on the construction of your motor, you may need to configure one or more axes to the low inductance setting rather than the default standard inductance setting. Table 6 shows the motor inductance level ranges for the two different settings.

Table 6. Motor Inductance Levels

Motor Inductance	MID-7654/7652 Setting
Greater than 440 μ H	Standard
Between 110 and 440 μ H	Low

Use the last DIP switch on each of the 9-position DIP switch banks to set the motor inductance level for each axis. Refer to Figures 1 and 3 for the location of the of the motor inductance level switch. Table 7 shows the DIP switch settings for low and standard motor inductance.

Table 7. Motor Inductance Level DIP Switch Settings

Switch Setting	Operation
	Low motor inductance
	Standard motor inductance (factory default)

Back Panel Connector Wiring

Figure 6 shows the MID-7654/7652 back panel connectors without their rear guards.

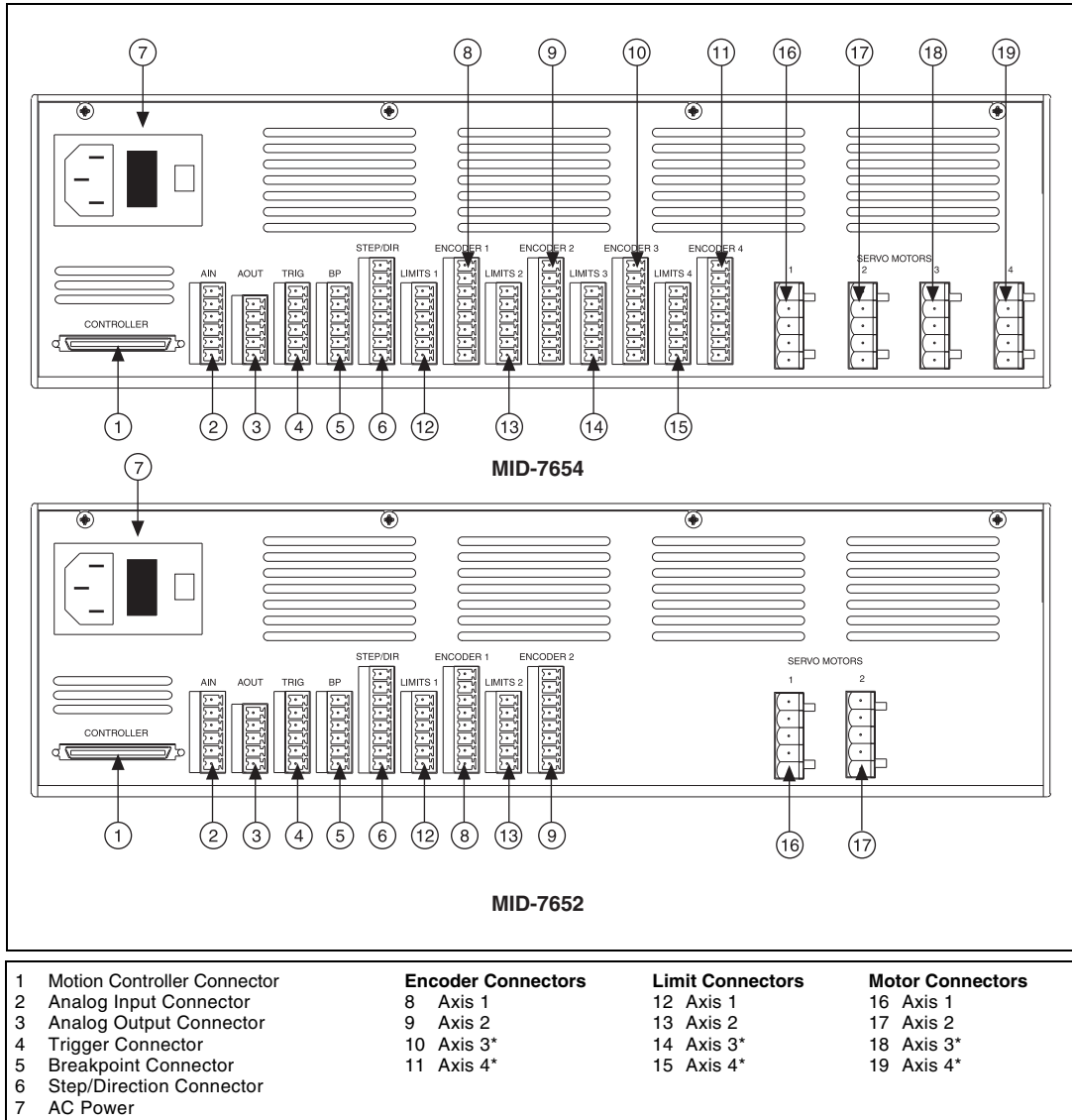

Figure 6. MID-7654/7652 Back Panel Connectors



Note Items followed by an asterisk (*) are available on the MID-7654 only.



Caution Be sure to turn off the ENABLE and AC POWER switches for your MID-7654/7652 and host computer and disconnect the unit from the power outlet before making connections to your motion controller.



Caution The servo motor connectors on this drive are energized when the unit is powered on. The rear guard must be in place at all times while the unit is connected to a power outlet. Disconnect the MID-7654/7652 unit from power outlet before connecting wires to or disconnecting wires from the servo motor connectors. Strip back the insulation of the servo motor wires to the servo motor connectors no more than 7 mm. Reattach the rear guard before you reconnect the unit to a power outlet. **Failure to do so could result in electric shock leading to serious bodily injury or death.** Refer to the [Rear Guard](#) section of this guide for information on using the rear guard.

Take the following steps to wire your motion system to your MID-7654/7652:

1. Connect the motion controller to the MID-7654/7652 using the interface cable. Wire the motor power, limit switch, encoder, and I/O terminal blocks to your motion control system.
2. For proper operation, configure the power entry module to match the voltage of your power source. Refer to the [Modifying the Power Entry Module](#) section for more information.



Caution You *must* change the MID-7654/7652 main input fuse on the rear panel if you change the line voltage from the factory setting. Refer to the [Replacing a Fuse](#) section in the [Modifying the Power Entry Module](#) section of this guide for information on changing a fuse.

3. Install the power cord into the back panel AC connector and plug it into a correctly rated power source.

Terminal Block Wiring

This section describes how to wire the terminal blocks on your MID-7654/7652.

Servo Motor Power Terminal Blocks

For motor power wiring, each MID-7654/7652 axis has a separate 5-position removable screw terminal block. Figure 7 shows a typical servo motor configuration pin assignment. The dotted loop indicates a shielded cable.

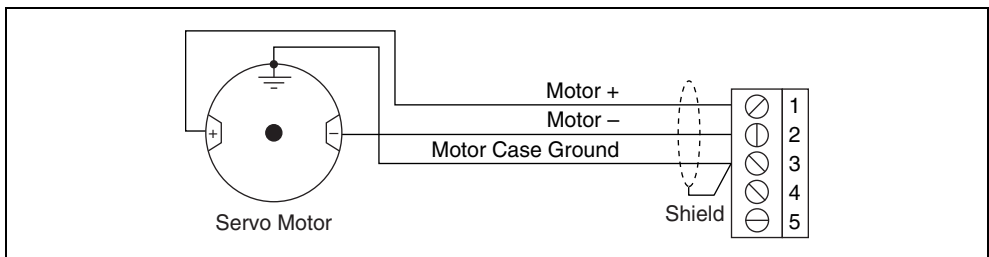

Figure 7. Typical Servo Motor (DC Brush Type) Terminal Block Pin Assignment



Caution The servo motor connectors on this drive are energized when the unit is powered on. The rear guard must be in place at all times while the unit is connected to a power outlet. Disconnect the MID-7654/7652 unit from power outlet before connecting wires to or disconnecting wires from the servo motor connectors. Strip back the insulation of the servo motor wires to the servo motor connectors no more than 7 mm. Reattach the rear guard before you reconnect the unit to a power outlet. **Failure to do so could result in electric shock leading to serious bodily injury or death.** Refer to the [Rear Guard](#) section of this guide for information on using the rear guard.

You should use shielded 20 AWG wire or larger for the motor power cable. If available, connect a motor case ground wire to pin 3 (Ground/Shield) on the MID-7654/7652 as shown in Figure 7; this wire helps avoid ground loops and signal noise problems. (Case ground connects to the motor housing, not to any of the motor power terminals.)



Caution *Never connect unused center taps or winding terminals to pin 3.*

Depending on your motor, you may need to reverse the connections shown in Figure 7, as there is no industry standard for direction of movement relative to the positive and negative motor inputs. Table 8 shows the National Instruments motion control standard directional polarity.

Table 8. National Instruments Standard Directional Polarity

Commanded Direction	Description	Motor Signal Relationship	Command Signal
Forward	Clockwise (CW) facing motor shaft	Motor – is greater than Motor +	Positive voltage
Reverse	Counter-clockwise (CCW) facing motor shaft	Motor + is greater than Motor –	Negative voltage

Figure 8 shows clockwise and counter-clockwise motor rotation.

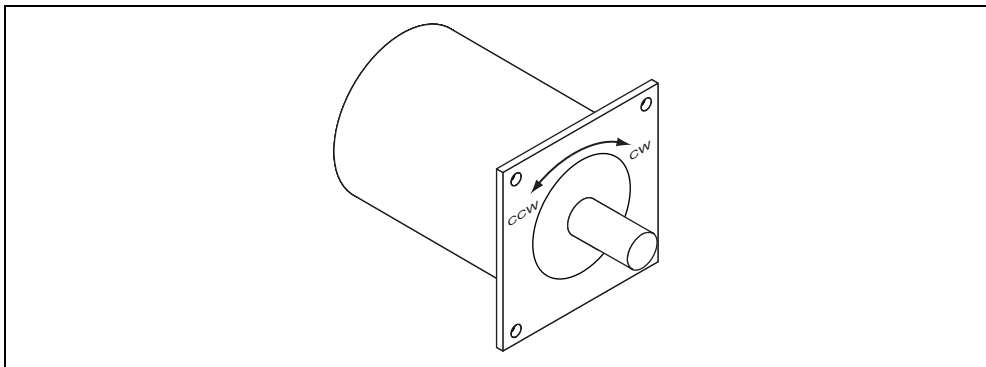
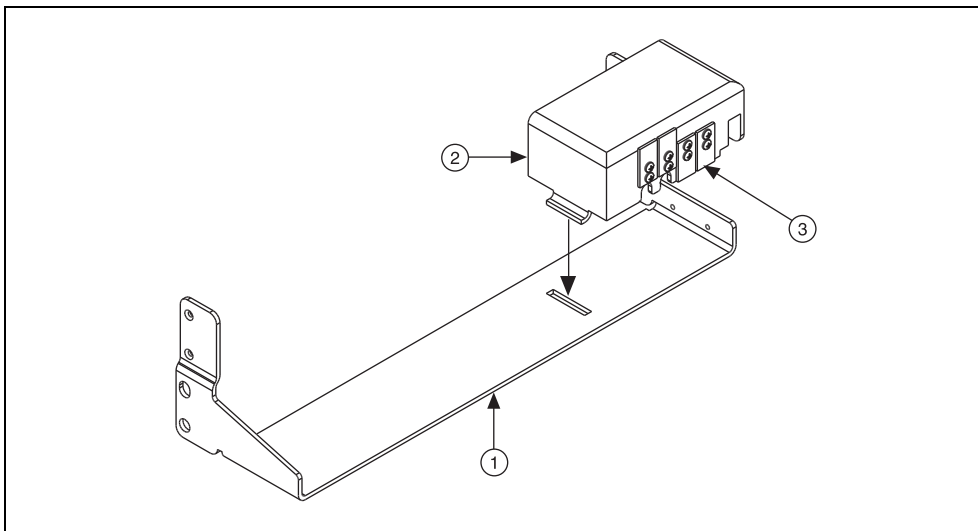

Figure 8. Clockwise and Counter-Clockwise Motor Rotation

Rear Guard

The rear guard consists of the protection cover, protection plates, and bottom mounting plate as shown in Figure 9.



1 Bottom Mounting Plate	2 Protection Cover	3 Protection Plate
-------------------------	--------------------	--------------------

Figure 9. Rear Guard Consisting of the Protection Cover, Protection Plates, and Bottom Mounting Plate
The rear guard installed on the MID-7654/7652 is shown in Figure 10.

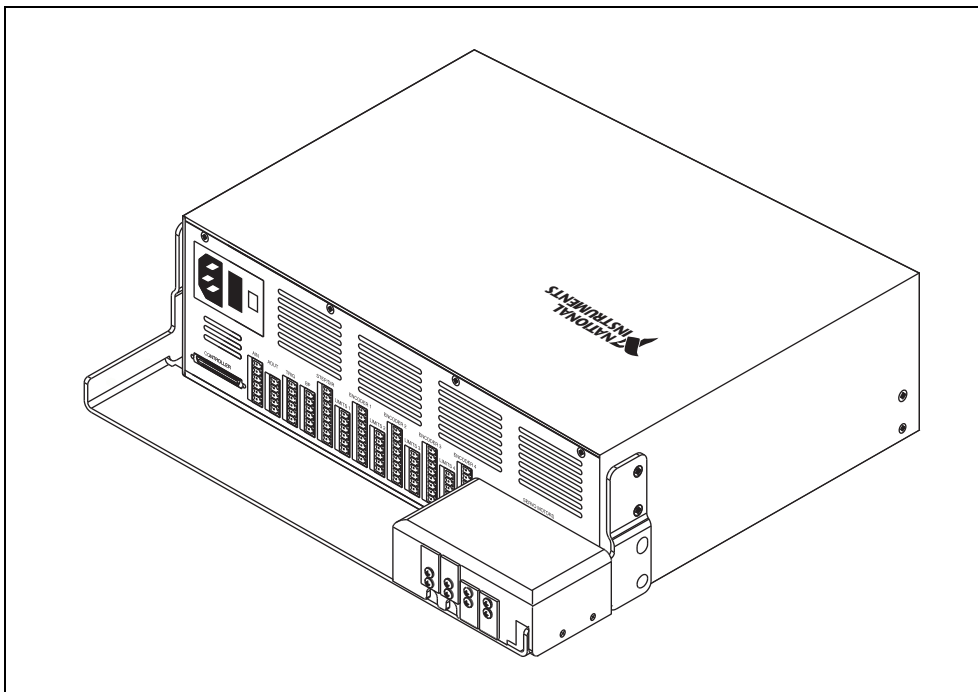

Figure 10. Rear Guard Installed on the MID-7654/7652



Caution The servo motor connectors on this drive are energized when the unit is powered on. The rear guard must be in place at all times while the unit is connected to a power outlet. Disconnect the MID-7654/7652 unit from power outlet before connecting wires to or disconnecting wires from the servo motor connectors. Strip back the insulation of the servo motor wires to the servo motor connectors no more than 7 mm. Reattach the rear guard before you reconnect the unit to a power outlet. *Failure to do so could result in electric shock leading to serious bodily injury or death.*

Follow these steps carefully to ensure safe operation of your MID-7654/7652:

1. Ensure that the MID-7654/7652 is powered off and disconnected from the power outlet before wiring any cables to the unit. The +5V green LED should not be illuminated after the MID-7654/7652 is powered off and disconnected from the power outlet.
2. Ensure that the bottom mounting plate of the rear guard is securely fastened to both sides of the MID-7654/7652, as shown in Figure 10.
3. Remove the protection plates for the axes to be used, rotate, and re-install the protection plates in the open position, as shown in Figure 11.

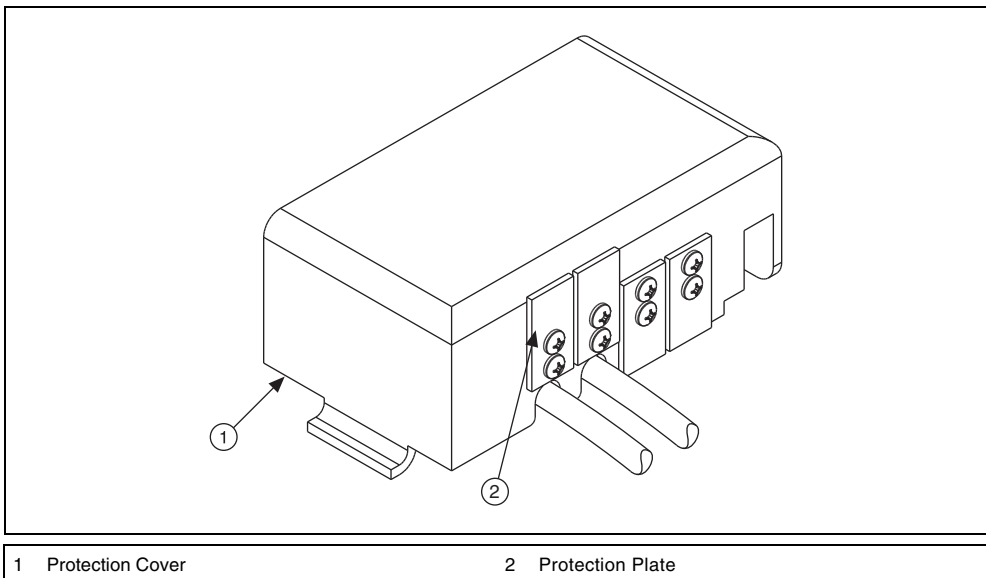

Figure 11. Protection Cover and Protection Plates: Used Axes 1 & 2, Unused Axes 3 & 4.



Note The protection plates for any unused axes should remain installed in the closed position at all times, as shown on axes 3 and 4 in Figure 11. For axes you are using, the protection plates must be removed, rotated, and re-installed in the open position, as shown on axes 1 and 2 in Figure 11.

Contact your National Instruments sales representative to replace lost protection plates (part number 188063A-01).

4. Remove the protection cover using the following procedure:
 - a. Remove the two screws that attach the protection cover to the side of the bottom mounting plate, as shown in Figure 10.
 - b. Lift the protection cover from the slot on the bottom mounting plate, as shown in Figure 9.

5. Plug the servo motor cables into the servo motor terminals of the MID-7654/7652. The cables must be placed over the bottom mounting plate of the rear guard.
6. Re-attach the protection cover
 - a. Insert the tab of the protection cover, shown in Figure 9, into the slot on the bottom mounting plate.
 - b. Lower the protection cover over the servo motor cables and secure it to the side of the bottom mounting plate using the two screws you removed in step 4.
7. Ensure that the rear guard is held securely in place before reconnecting your MID-7654/7652 to a power outlet.

Encoder Terminal Blocks

For quadrature incremental encoder signals, each MID-7654/7652 axis has a separate 8-position removable screw terminal block. Where applicable, the MID-7654/7652 accepts two types of encoder signal inputs: single-ended (TTL) or differential line driver. You can accommodate open-collector output encoders by using 2.2 k Ω pullup resistors to +5 VDC.

Figure 12 shows the typical encoder wiring pin assignment for single-ended signal input.



Note The dotted loop indicates a shielded cable. A line above a signal indicates that the signal is active low.

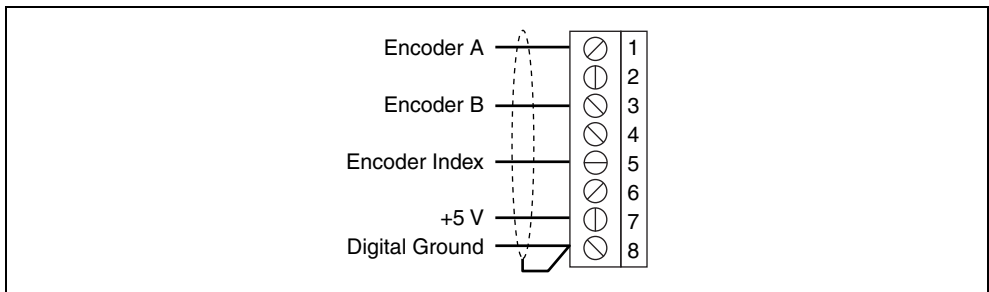

Figure 12. Typical Single-Ended Encoder Wiring Pin Assignment

Figure 13 shows the typical encoder wiring pin assignment for differential line driver signal inputs.

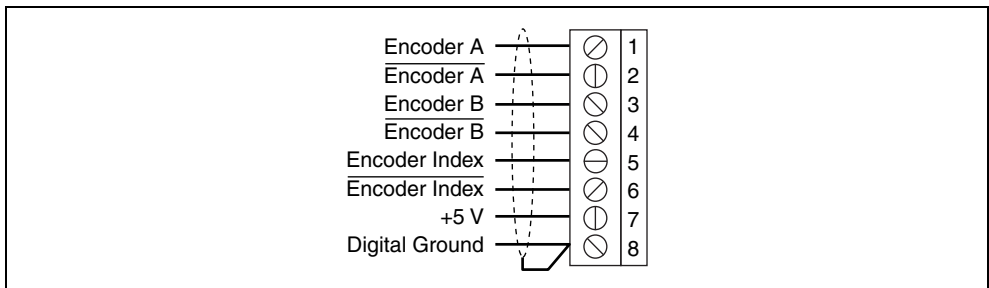

Figure 13. Typical Differential Line Driver Encoder Wiring Pin Assignment

If the encoder cable length is greater than 10 ft, use encoders with line driver outputs for your applications. Power for a +5 V encoder—generated by a power supply inside the MID-7654/7652—is available on pin 7.



Note If you require other encoder power voltages, reference an external power supply to the Digital Ground signal on the 8-pin encoder terminal block.

The MID-7654/7652 supports differential inputs for Phase A, Phase B, and Index signals. You can easily accommodate encoders with various phase relationships by swapping the signals and/or connecting them to the inverting inputs as required by your application. The Index signal must occur when both Phase A and Phase B signals are low, as shown in Figure 14. If the Index polarity is inverted, try reversing the Index and $\overline{\text{Index}}$ signals on differential encoders or using the $\overline{\text{Index}}$ input on single-ended encoders.

Figure 14 shows the proper encoder phasing for CW (forward) motor rotation.

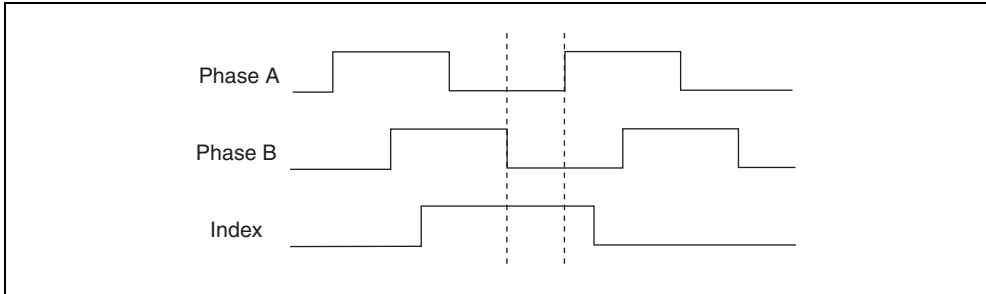

Figure 14. Encoder Signal Phasing, CW Rotation

Closed-loop servo applications require consistent directional polarity between the motor and encoder for correct operation. The National Instruments motion control standard directional polarity is as follows:

- Positive = forward = clockwise (CW) facing motor shaft
- Negative = reverse = counter-clockwise (CCW) facing motor shaft

Refer to Figure 8 for a depiction of clockwise and counter-clockwise rotation.

When connecting the encoder wiring to your MID-7654/7652, use shielded wire of at least 24 AWG. You must use cables with twisted pairs and an overall shield for improved noise immunity and enhanced encoder signal integrity. Figure 15 shows twisted pairs in a shielded cable.

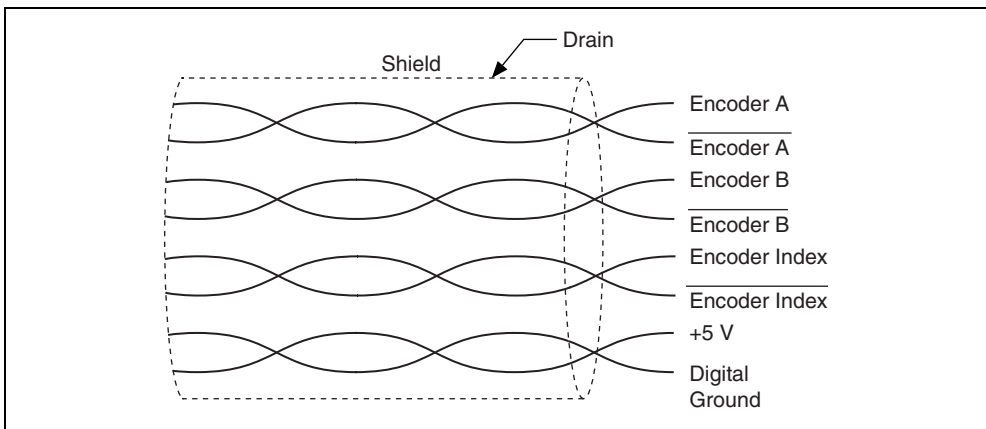

Figure 15. Shielded Twisted Pairs



Note Using an unshielded cable may produce noise, which can corrupt the encoder signals and cause lost counts, reduced accuracy, or other erroneous encoder and controller operation.

Limit Switch Terminal Blocks

For end-of-travel limit, home, inhibit input, and inhibit output connections, MID-7654/7652 axes have a separate, 6-position removable screw terminal connector block. Figure 16 shows the limit switch terminal block pin assignments.

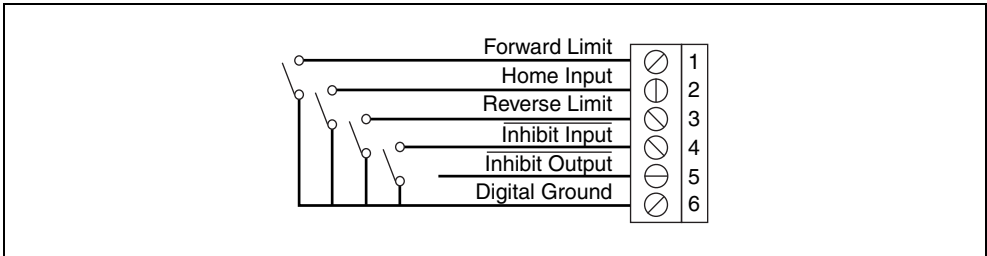

Figure 16. Limit Switch Terminal Block Pin Assignment
(Passive Limit Switch Connection Example)

You can configure the inhibit output signal to be asserted low or asserted high from the MID-7654/7652 when an axis is inhibited. This signal can be useful for actuating mechanical brakes or for monitoring an axis status. Refer to the [Amplifier Inhibit LEDs](#) section of this guide for a description of the conditions that will cause an axis to be inhibited.

Breakpoint and Trigger Terminal Blocks

Both the breakpoint and trigger connectors use a 6-pin removable terminal block.

The trigger terminal block provides access to the trigger input lines, shutdown input line, and digital ground. The breakpoint terminal block provides access to the breakpoint output lines, the +5 V supplied by the MID-7654/7652, and the digital ground. Figures 17 and 18 show the breakpoint and trigger 6-position terminal block assignments.

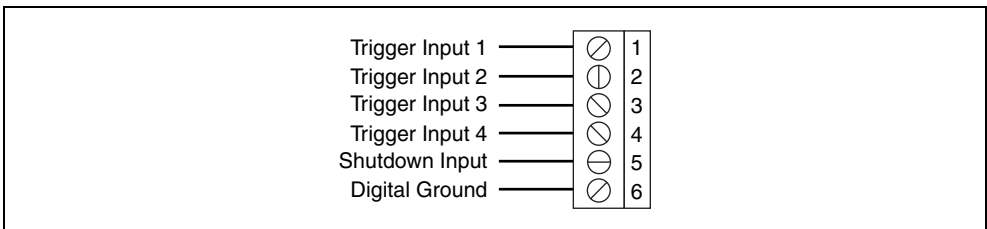

Figure 17. Trigger Terminal Block Pin Assignment

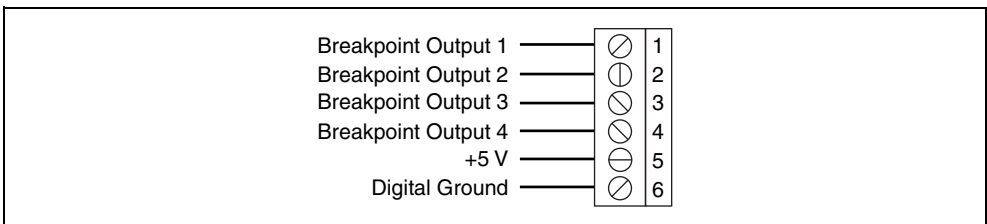

Figure 18. Breakpoint Terminal Block Pin Assignment

Analog I/O Terminal Blocks

The MID-7654/7652 features two analog I/O connectors.

The analog input connector uses a 6-pin removable terminal block, which provides access to four analog-to-digital converter channels, an analog reference voltage from the converter circuit, and an analog input ground signal.

The analog output connector uses a 5-pin removable terminal block, which provides access to four digital-to-analog converter channels and analog output ground. Refer to Figures 19 and 20 for terminal block pin assignments.

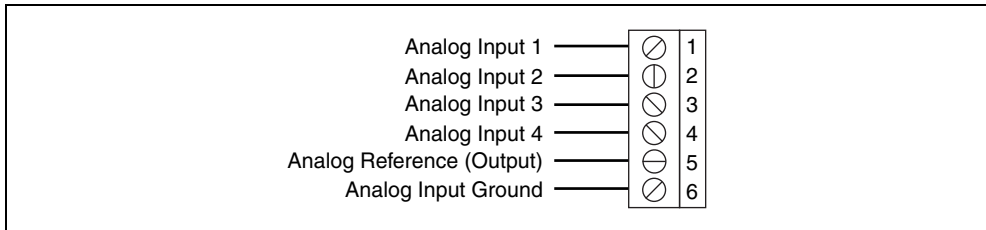

Figure 19. Analog Input Terminal Block Pin Assignment

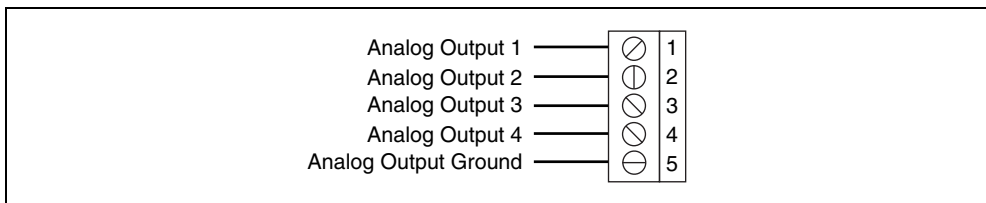

Figure 20. Analog Output Terminal Block Pin Assignment

Step and Direction Terminal Block

The MID-7654/7652 passes step and direction signals from the controller directly through the drive, allowing you to access them through the 8-pin removable terminal block. This feature is useful if your system includes both stepper and servo motors, as it reduces the amount of custom cabling required to connect your motors and drives to the controller.

To use the step and direction connector, select an unused axis on the MID-7654/7652 and connect the step and direction outputs for that axis to your stepper drive. Refer to Figure 21 for the terminal block pin assignments. Connect additional signals for the axis, such as inhibit outputs, limit switches, breakpoints and triggers, and encoder feedback, as described earlier in this guide.

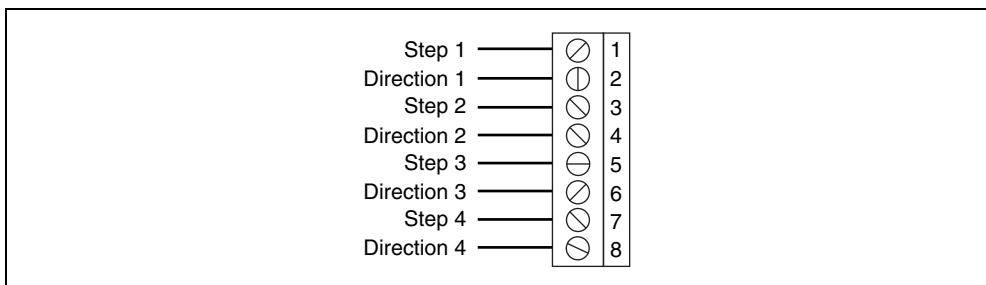

Figure 21. Step and Direction Terminal Block Pin Assignment

Cable Installation for CE Compliance

Take the following additional steps to ensure CE Compliance:

1. Enclose the terminal block wires in a 360-degree shielded cable. This requires a braided shield.
2. Install the strain-relief bar on the MID-7654/7652 as described in the [Accessories Included for Optional Use](#) section of this guide.
3. Place all cables connecting to the back panel through the strain-relief bar, as follows:
 - a. All servo motor cables must pass through the far right clamp on the strain-relief bar, which is directly aligned with the servo motor terminals and protection cover.
 - b. All remaining cables should pass through the three clamps to the left of the servo motor terminals.
 - c. Cables passing through the same clamp must be of the same cable diameter.
 - d. Cables passing through the same clamp must be parallel and must not overlap each other, as shown in Figure 22.
4. All cables must be properly grounded to the strain-relief bar, which grounds them to the MID-7654/7652 chassis ground. Follow these steps to ground the cables to the strain-relief bar:
 - a. Remove the outer jacket from the section of the cable to be inserted between the strain-relief bar clamp and foam, as shown in Figure 22. This will expose the braided shield of the cable.



Note Do *not* cut the braided shield of the cable.

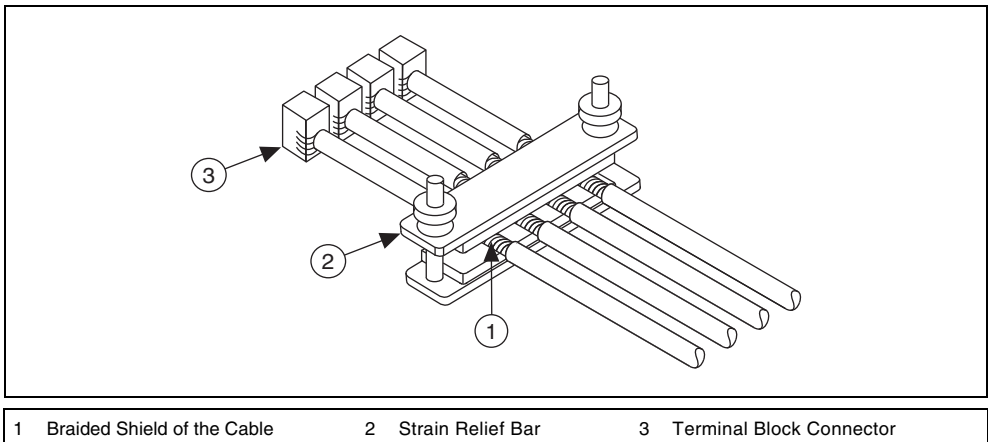

Figure 22. Required Cabling for CE Compliance

- b. Lay the cables so that the braided shield makes full contact with the foam of the strain-relief bar. The braided shield must only make contact with the strain-relief bar, and no other part of the device.
 - c. Lower the clamp and tighten the thumb nuts to remove all gaps between the foam and the cable shields. The foam should press around the shield of the cable to provide 360-degree grounding to the cable shield.
5. Ground the braided shield at the opposite end of the cables to your destination enclosure ground.

Accessories Included for Optional Use

Strain-Relief Bar Installation

The strain-relief bar provides strain relief for wiring to the back panel terminals of the MID-7654/7652. It must be used to provide necessary grounding for CE compliance. Refer to the [Cable Installation for CE Compliance](#) section of this guide for more information.

The arms of the strain-relief bar attach between the sides of the MID-7654/7652 and the bottom mounting plate of the rear guard with the thumb nuts facing upwards, as shown in Figure 23. Refer to the [Rear Guard](#) section of this guide for more information on removing and replacing the protection cover from the rear guard. Refer to Figure 23 while following these strain-relief bar installation steps:

1. Remove the protection cover of the rear guard.
2. Place the strain-relief bar so it fits within the sides of the bottom mounting plate.
3. Attach the strain-relief bar to the side panels of the MID-7654/7652 using the provided screws.
4. Replace the protection cover.

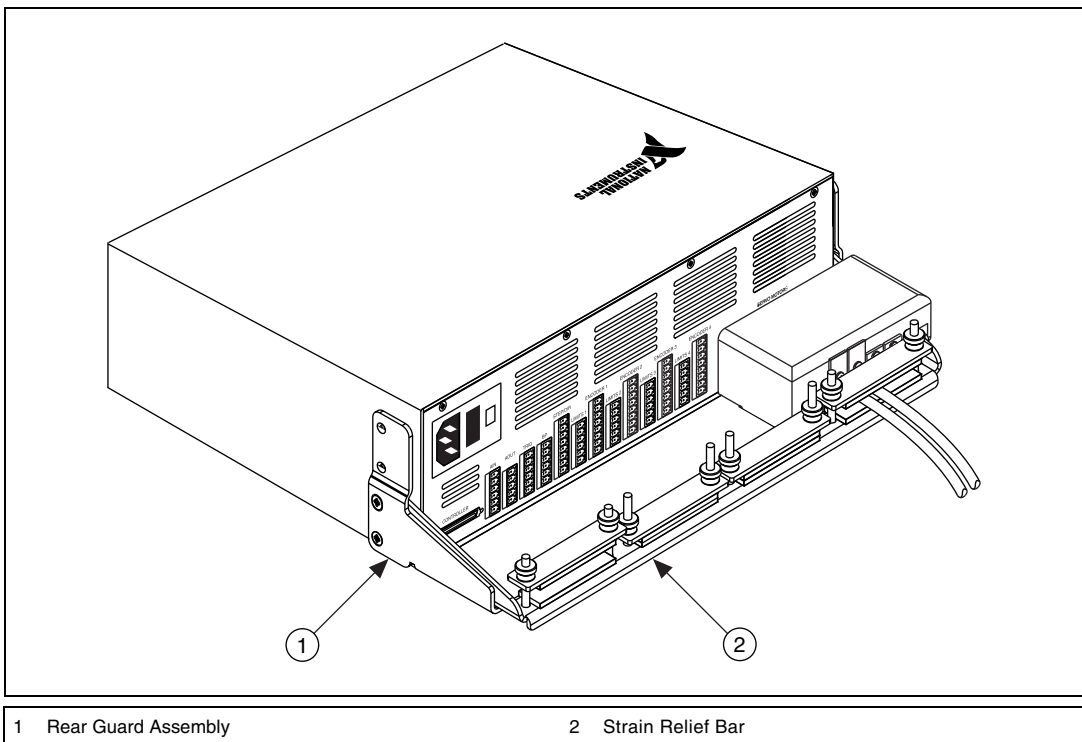

Figure 23. MID-7654/7652 with the Strain-Relief Bar Installed

Changing the Line Voltage

Follow these steps to change the line voltage on your MID-7654/7652:

1. Pry open the hinged cover on the power entry module (number 7 in Figure 6).
2. Remove the fuse holder.
3. Replace the two fuses with the appropriate fuses for the desired line voltage as listed in the *Specifications* section.
4. Rotate the fuse holder 180 degrees so the desired line voltage number shows through the window when the power module cover is closed.
5. Push the fuse holder back into the power entry module with the new orientation.
6. Close the hinged cover.

Amplifier/Driver Command Signals

The PWM amplifiers used in the MID-7654/7652 accept an industry-standard ± 10 V analog torque (current) command signal. Servo motion controllers used with the MID-7654/7652 provide this standard output and are programmed to close both the velocity loop and position loop using an enhanced PID algorithm.

Specifications

The following specifications apply only to the MID-7654/7652. You must account for your motion controller to obtain a system specification. Refer to your controller specifications to determine overall system specifications.

Some signals define compatibility as signal pass-through, which means the MID-7654/7652 may use passive filtering on these signals. This will not affect the voltage range or current handling capability. Consult your motion controller specifications to determine the allowable voltage range and logic level compatibility of the signal.

Servo Amplifiers

Type.....	Elmo Motion Control VIO 10/100
Peak current limit (2.7 s).....	1.7–10 A (default 1.7 A)
Continuous current limit	0.85–5 A (default 0.85 A)
DC-bus motor voltage.....	48 VDC
PWM frequency	32 kHz
Continuous power output rating (all axes combined)	400 W at 25% duty cycle

Encoders

Inputs	Quadrature, incremental
Differential input threshold.....	± 0.3 V (typical)
Single ended input threshold.....	TTL/CMOS
Voltage range	0–5 VDC
Maximum quadrature frequency.....	20 MHz

Limit and Home Switch Inputs

CompatibilitySignal pass-through

Inhibit Inputs

Voltage range0–12 VDC

Input low voltage0.8 V

Input high voltage2 V

Inhibit Outputs

Voltage range0–5 VDC

Output low voltage.....0.5 V at 64 mA

Output high voltage.....2.4 V at 32 mA

Trigger Input

Noise filter (RC time constant).....100 ns

CompatibilitySignal pass-through

Breakpoint Outputs

CompatibilitySignal pass-through

Analog Inputs

Noise filter (RC time constant).....10 μ s

CompatibilitySignal pass-through

Analog Outputs

CompatibilitySignal pass-through

Step/Direction Outputs

CompatibilitySignal pass-through

Shutdown Input

CompatibilitySignal pass-through

User 5 V Supply

Voltage range @ 0.5 A.....4.7 to 5.2 V

Included Connectors

Encoders.....8-position mini-combicon 3.81 mm plug (1 per axis)

Limits6-position mini-combicon 3.81 mm plug (1 per axis)

Servo Motors.....5-position combicon 5.08 mm plug (1 per axis)

Breakpoints6-position mini-combicon 3.81 mm plug (1 total)

Triggers6-position mini-combicon 3.81 mm plug (1 total)

Step/Direction8-position mini-combicon 3.81 mm plug (1 total)

Analog input6-position mini-combicon 3.81 mm plug (1 total)

Analog output	5-position mini-combicon 3.81 mm plug (1 total)
AC power	Detachable AC power cord (IEC standard type)
Motion I/O	68-pin female high density VHDCI type

Power Supply

Input voltage	90–132 VAC / 198–264 VAC, 47–63 Hz
Input fuse	
115 VAC (factory default).....	8 A (Littelfuse #312008)
230 VAC.....	6 A (Littelfuse #312006)
Input fuse dimensions	0.25 in. × 1.25 in.
Input Power Peak Current (at max load)	
115 VAC.....	10 A
230 VAC.....	5 A
Installation category.....	II

Environment

Operating temperature	0 to 50 °C (32 to 122 °F)
Storage temperature	–20 to 70 °C (–4 to 158 °F)
Humidity	10% to 90% RH, noncondensing
Maximum altitude.....	2,000 m
Pollution Degree	2

Host Bus Voltage Interlock

Undervoltage threshold.....	4 VDC
-----------------------------	-------

Physical

Dimensions (W × H × L).....	25.4 cm × 8.8 cm × 30.6 cm (10 in. × 3.5 in. × 12.0 in.)
Weight.....	10.2 kg (22.5 lb.)

Safety

This product is designed to meet the requirements of the following standards of safety for electrical equipment for measurement, control, and laboratory use:

- EN 61010-1:1993/A2:1995, IEC 61010-1:1990/A2:1995
- UL 3101-1:1993, UL 3111-1:1994, UL 3121-1:1998
- CAN/CSA C22.2 No. 1010.1:1992/A2:1997

UL Recognized to UL 508C, power conversion equipment, File # E208822



Note For UL and other safety certifications, refer to the product label or the [Online Product Certification](#) section.

Electromagnetic Compatibility

This product meets the requirements of the following EMC standards for electrical equipment for measurement, control, and laboratory use:

- EMC/EMI: CE, C-Tick and FCC Part 15 (Class A) Compliant.
- Electrical emissions: EN 55011 Class A @ 10 meters FCC Part 15A above 1 GHz.
- Electrical immunity: Evaluated to EN 61326:1998, Table 1



Note For the standards applied to assess the EMC of this product, refer to the *Online Product Certification* section.



Note For EMC compliance, operate this device according to the documentation.

CE Compliance

This product meets the essential requirements of applicable European Directives as follows:

- 2006/95/EC; Low-Voltage Directive (safety)
- 2004/108/EC; Electromagnetic Compatibility Directive (EMC)

Online Product Certification

Refer to the product Declaration of Conformity (DoC) for additional regulatory compliance information. To obtain product certifications and the DoC for this product, visit ni.com/certification, search by module number or product line, and click the appropriate link in the Certification column.

Environmental Management

National Instruments is committed to designing and manufacturing products in an environmentally responsible manner. NI recognizes that eliminating certain hazardous substances from our products is beneficial to the environment and to NI customers.

For additional environmental information, refer to the *NI and the Environment* Web page at ni.com/environment. This page contains the environmental regulations and directives with which NI complies, as well as other environmental information not included in this document.

Waste Electrical and Electronic Equipment (WEEE)



EU Customers At the end of the product life cycle, all products *must* be sent to a WEEE recycling center. For more information about WEEE recycling centers, National Instruments WEEE initiatives, and compliance with WEEE Directive 2002/96/EC on Waste and Electronic Equipment, visit ni.com/environment/weee.

电子信息产品污染控制管理办法（中国 RoHS）



中国客户 National Instruments 符合中国电子信息产品中限制使用某些有害物质指令 (RoHS)。关于 National Instruments 中国 RoHS 合规性信息, 请登录 ni.com/environment/rohs_china。(For information about China RoHS compliance, go to ni.com/environment/rohs_china.)

Where to Go for Support

The National Instruments Web site is your complete resource for technical support. At ni.com/support you have access to everything from troubleshooting and application development self-help resources to email and phone assistance from NI Application Engineers.

A Declaration of Conformity (DoC) is our claim of compliance with the Council of the European Communities using the manufacturer's declaration of conformity. This system affords the user protection for electromagnetic compatibility (EMC) and product safety. You can obtain the DoC for your product by visiting ni.com/certification. If your product supports calibration, you can obtain the calibration certificate for your product at ni.com/calibration.

National Instruments corporate headquarters is located at 11500 North Mopac Expressway, Austin, Texas, 78759-3504. National Instruments also has offices located around the world to help address your support needs. For telephone support outside the United States, contact your local branch office. You can visit the *Worldwide Offices* section of ni.com/niglobal to access the branch office Web sites, which provide up-to-date contact information, support phone numbers, email addresses, and current events.

LabVIEW, National Instruments, NI, ni.com, the National Instruments corporate logo, and the Eagle logo are trademarks of National Instruments Corporation. Refer to the *Trademark Information* at ni.com/trademarks for other National Instruments trademarks. Other product and company names mentioned herein are trademarks or trade names of their respective companies. For patents covering National Instruments products/technology, refer to the appropriate location: **Help»Patents** in your software, the `patents.txt` file on your media, or the *National Instruments Patent Notice* at ni.com/patents. Refer to the *Export Compliance Information* at ni.com/legal/export-compliance for the National Instruments global trade compliance policy and how to obtain relevant HTS codes, ECCNs, and other import/export data.